

EFORT

ESR10-700Z20

ESR10-700Z20,
Maxium payload 10 kg with maxium reach 700 mm.

- **Highlights**
 1. High rhythm and high precision
 The fastest standard cycle time can reach 0.385 s, and the robot positioning accuracy can reach 0.02 mm.
 2. High rigidity and low vibration
 Robot body mode and rigidity enhancement, combined with vibration suppression and active vibration suppression functions, effectively reduce vibration.
 3. Easy to maintain and scalable
 The detachable structure of cables and batteries allows for the replacement of robots inside the device, and the built-in camera network cable enables various communication extensions.
- **Applications**
 It can be used in handling, sorting, assembly, etc.
- **Industries**
 Suitable for industries such as 3C electronics, lithium batteries, automotive electronics, and photovoltaics.



SPECIFICATIONS

Model		ESR10-700Z20
Reach		700 mm
Max. payload on wrist	Rated	5 kg
	Maximum	10 kg
Robot weight		23 kg
Maximum speed	J1+J2	9800 mm/sec
	J3	1500 mm/sec
	J4	2500°/sec
Motion range	J1	±132°
	J2	±150°
	J3	200 mm
	J4	±360°
Repeatability	J1+J2	±0.02 mm
	J3	±0.01 mm
	J4	±0.01°
Standard cycle time		0.385 s
J4 allowable moment of inertia	Rated	0.02 kg·m ²
	Maximum	0.3 kg·m ²
Electric lines		D-Sub 15-Pin
Pneumatic lines		φ4 mmx1, φ6 mmx2
J3 downward force		200 N
Installation		Floor
Installation enviroment	Ambient temperature	5~40°C
	Ambient humidity	RH≤80% (No dew nor frost allowed)

OPERATING SPACE

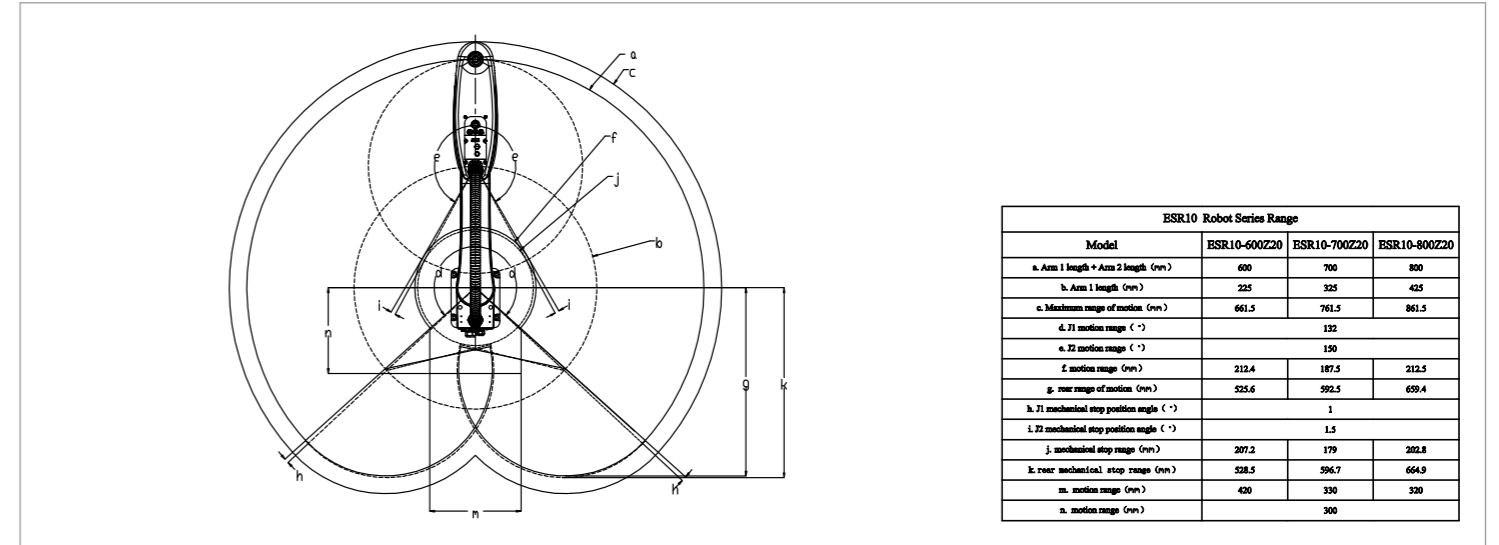

BASE MOUNTING SIZE

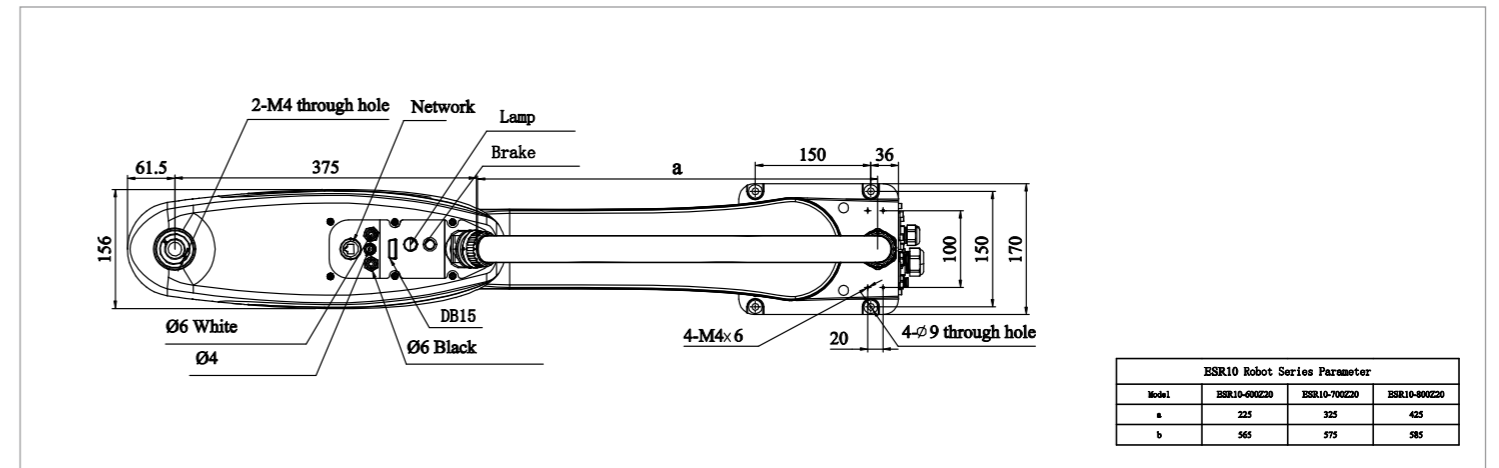

END FLANGE MOUNTING SIZE

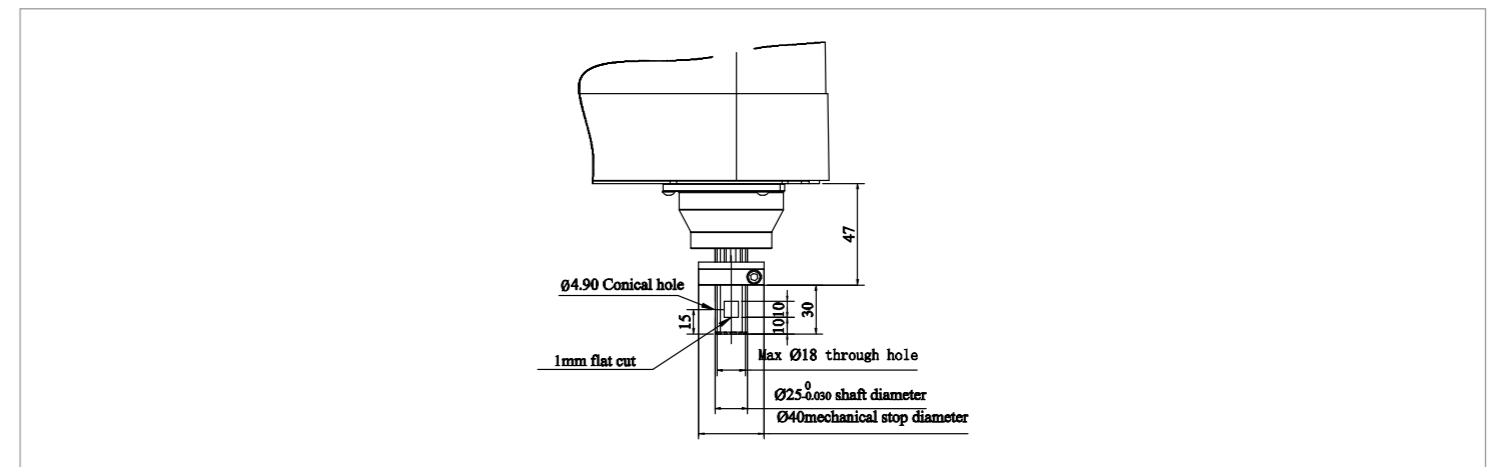

Information Release Time 2024/01

PHONE: (00 86) 400-052-8877
 ADDRESS: No.96 East Wanchun Road, China(Anhui) Pilot
 Free Trade Zone Wuhu Area, Wuhu, Anhui Province, China
 WWW.EFORT.COM.CN

EFORT INTELLIGENT EQUIPMENT CO.,LTD.