

ER25-1800

EFORT

ER25-1800,
Maxium payload 25 kg with maxium reach 1850 mm.

■ **Highlights**

Thanks to the new design of wrist, inertia and bearing capacity are increased by 25% with wider application scope;
Thanks to the high stiffness transmission design and advanced trajectory algorithm, the improved robot accuracy performance helps customers to face variety of application scenarios;
Lighter weight of the body, 20% less than its predecessor.

■ **Applications**

It can be used in handling operations, assembling, grinding, polishing, deburring, etc.

■ **Industries**

Suitable for metal parts, photovoltaic, logistics, food and beverage and other industries.



SPECIFICATIONS

Model	ER25-1800	
Type	Articulated	
Controlled axes	6 Axes	
Max. payload on wrist	25 kg	
Repeatability	±0.05 mm	
Robot weight	175 kg	
Reach	1850 mm	
Robot IP grade	IP54 / IP67 (Wrist)	
Cabinet IP grade	IP20 / IP54 (Optional)	
Drive mode	AC servo drive	
Installation	Floor, Upside-down, Wall	
Installation enviroment	Ambient temperature	0~45 °C
	Ambient humidity	RH≤80% (No dew nor frost allowed)
	Vibration acceleration	4.9 m/s ² (<0.5 G)

Allowable load moment at wrist	J4	50 N·m
	J5	50 N·m
	J6	30 N·m
Allowable load inertia at wrist	J4	2.2 kg·m ²
	J5	2.2 kg·m ²
	J6	1.5 kg·m ²
Maximum speed	J1	220°/sec
	J2	180°/sec
	J3	200°/sec
	J4	360°/sec
	J5	360°/sec
	J6	410°/sec
Motion range	J1	±170°
	J2	+77°-160°
	J3	+165°-85°
	J4	±190°
	J5	±130°
	J6	±360°

OPERATING SPACE

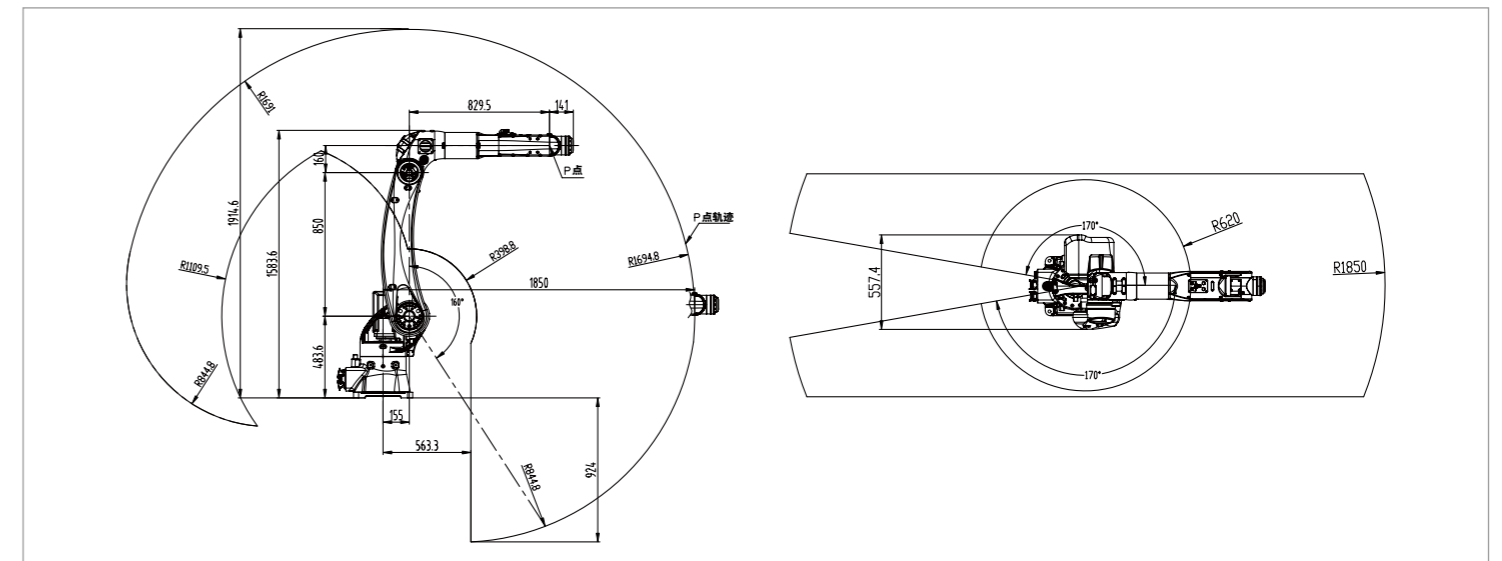

BASE MOUNTING SIZE

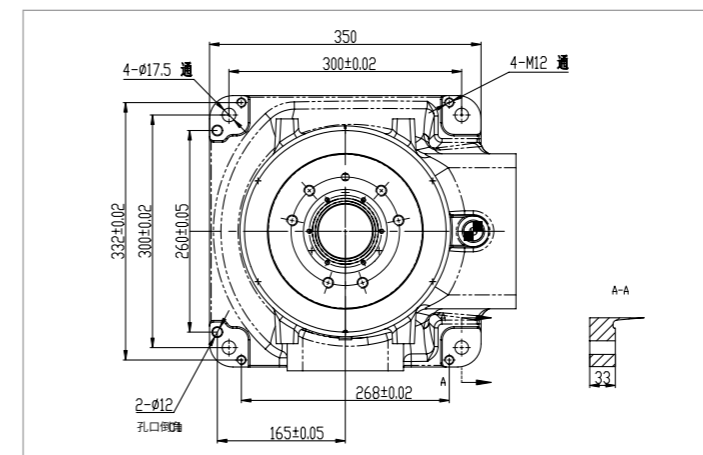

END FLANGE MOUNTING SIZE

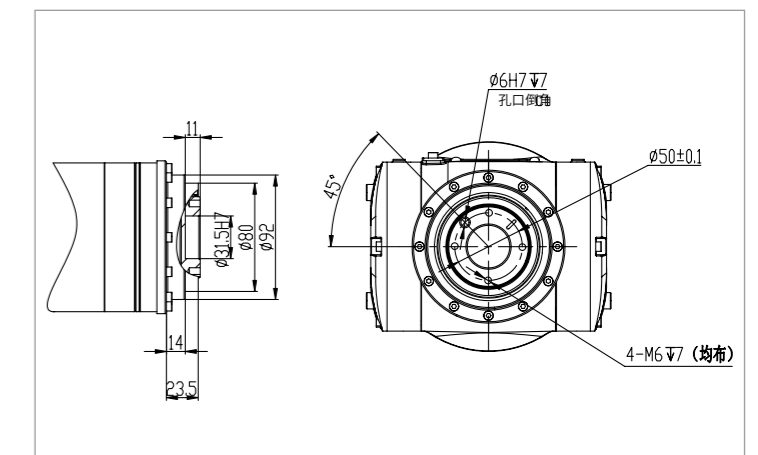

EFORT INTELLIGENT EQUIPMENT CO.,LTD.

PHONE: (00 86) 400-052-8877
ADDRESS: No.96 East Wanchun Road, China(Anhui) Pilot
Free Trade Zone Wuhu Area, Wuhu, Anhui Province, China
WWW.EFORT.COM.CN